











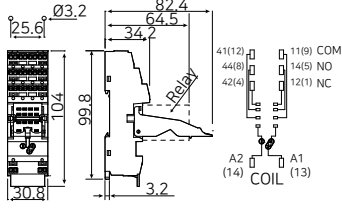
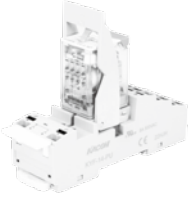

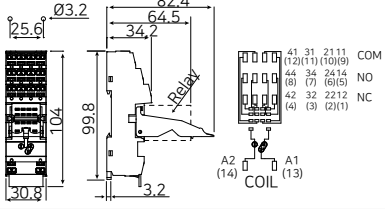
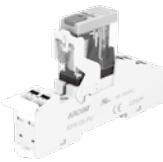
Socket

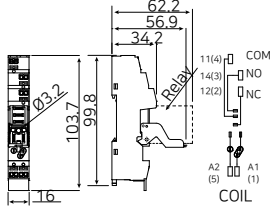
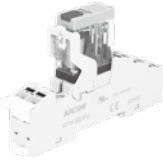
Product Selection & Dimension

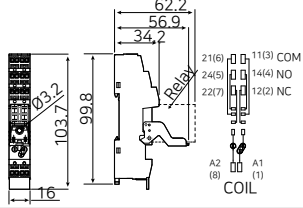
unit : mm

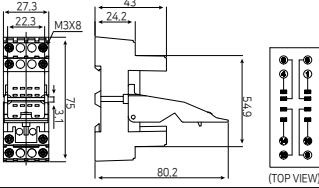

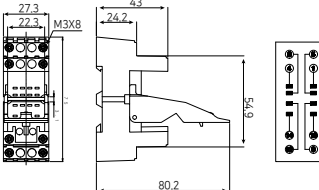







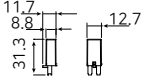

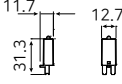

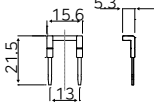
Part Number (Color)	Certification	Relay	Torque	Dimension
 KYF-08-PU		K705-2PL 505-2P HR705-2P	-	
 KYF-14-PU		K705-4PL 505-4P HR705-4P	-	
 KPX-05-PU		K706-1PL	-	
 KPX-08-PU		K706-2PL	-	
 KPY2 (White)		505-2P	0.5N·m	
 KPY4 (White)		505-4P	0.5N·m	

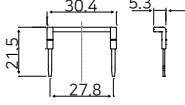
※ The number in () is the terminal number of the relay.
 ※ Please check the pin number of the product

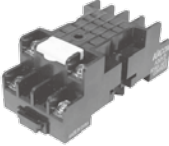
Socket

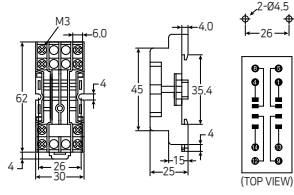
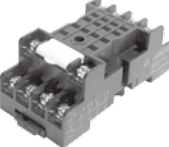
Product Selection & Dimension

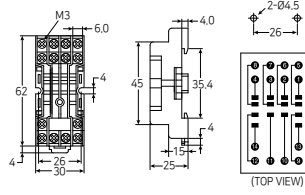

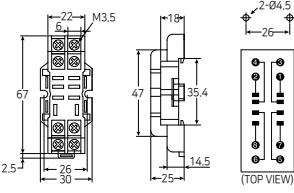







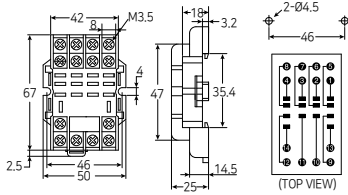
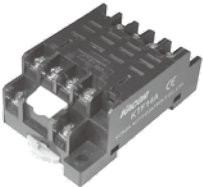

unit : mm

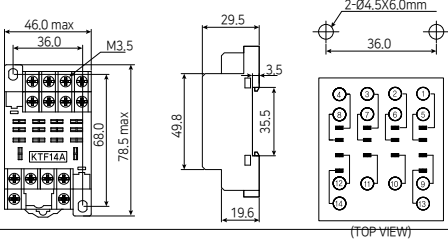
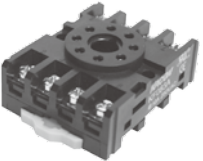
	Part Number (Color)	Certification	Relay	Torque	Dimension
	KPY-M		KPY-M1 24VDC/AC KPY-M2 110VDC/AC KPY-M3 220VDC/AC		
Varistor			KPY socket		
	KPY-D		6 ~ 250VDC KPY socket		
Diode					
	KPX-S02□ Color □ : C,K,R,B				
	KYF-S02□ Color □ : C,K,R,B				
	KPX-S20C				
	KMY2		505-2P HR705-2P	0.5N·m	
	KMY4 (R, G, Y, B, Amber, Black(Basic))		505-4P HR705-4P	0.5N·m	
	KLY2		HR710-2P	0.8N·m	

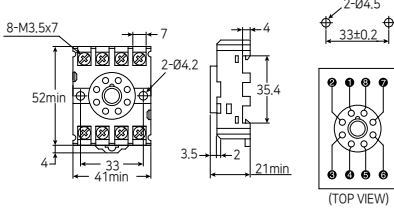
Socket

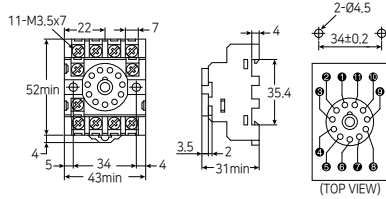
Product Selection & Dimension

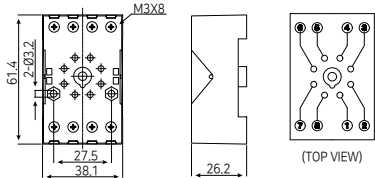
unit : mm

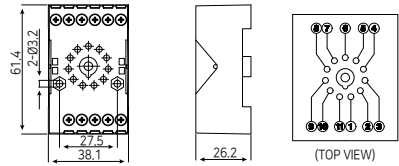
	Part Number (Color)	Certification	Relay	Torque	Dimension
	KLY4		HR710-4P	0.8N·m	
	KTF14A		HR710-4P	0.8N·m	
	KF083A		HR707N-2P TTS	0.8N·m	
	KF113A		HR707N-3P	0.8N·m	
	KPZ2		HR707N-2P TTL TTS	0.5N·m	
	KPZ3		HR707N-3P	0.5N·m	

※ Please check the pin number of the product

Rev. 2/14

Data subject may change without notice.











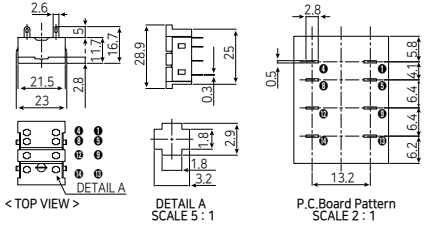

www.kacon.co.kr

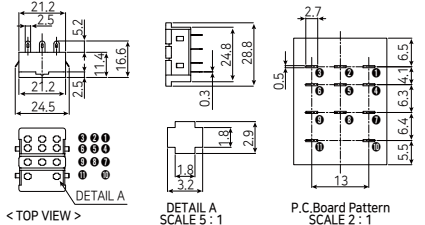
Industrial Controls Catalog

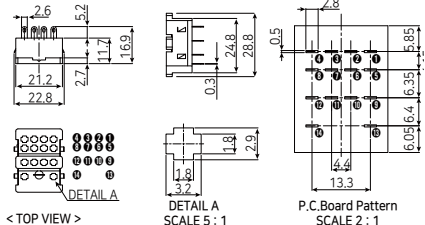
I - 37

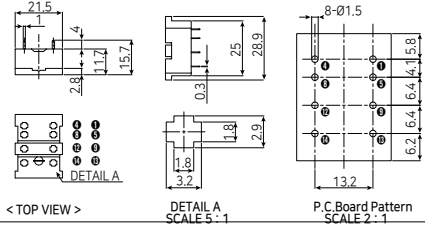
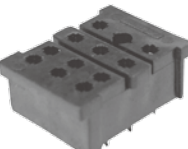

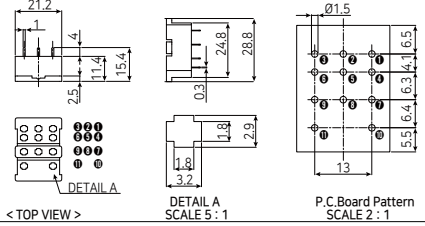

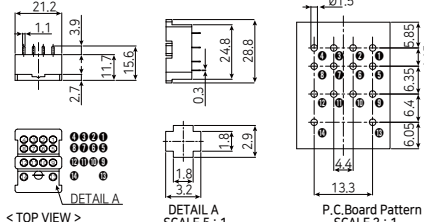

Product Selection & Dimension

unit : mm

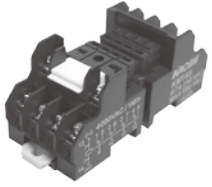
Part Number (Color)	Certification	Relay	Dimension
		505-2PL HR705-2P Soldering	
		HR705-3P Soldering	
		505-4P HR705-4P Soldering	
		505-2P HR705-2P PCB Type	
		HR705-3P PCB Type	
		505-4P HR705-4P PCB Type	

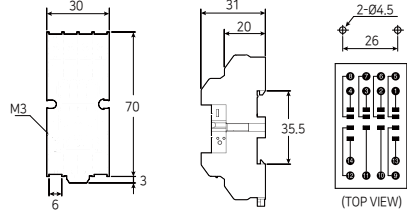
Product Selection & Dimension

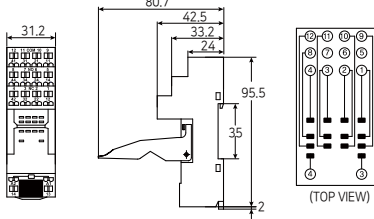

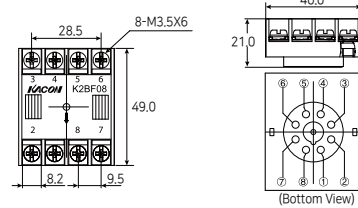





unit : mm

	Part Number (Color)	Certification	Relay	Torque	Dimension
	KMY4S G (Green)		50S-4P HR705-4P	0.5N·m	 (TOP VIEW)
	KPY4		50S-4P HR705-4P 납땜용	-	 (TOP VIEW)
	K2BF08		TTL	0.8N·m	 (Bottom View)

Socket

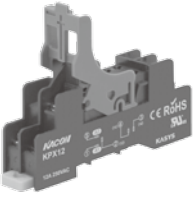
Product Selection & Dimension

unit : mm

Part Number (Color)	Certification	Relay	Torque	Dimension
	CE 	-	0.5N·m	
	CE 	-	0.5N·m	
	CE  RoHS	K706-1PL	0.5N·m	
	CE 	K706-1PL Soldering	-	

※ Please check the pin number of the product

